

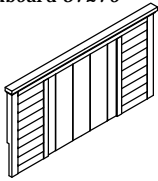

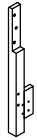

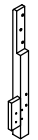

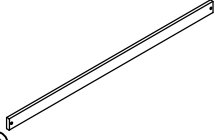

Warning :

- Be sure to check all packing material carefully for small parts, which may have come loose inside the carton during shipment.
- To prevent possible scratches and damage, this furniture **MUST BE ASSEMBLED BY TWO PEOPLE** on a soft surface such as a blanket or carpet.





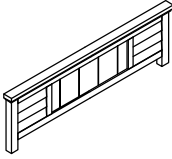
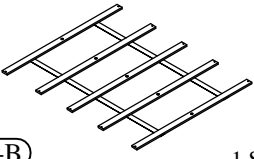

Hardware and Parts packed with the Headboard

<p>Louver Headboard 37276</p>  <p>(H-A) 1 pc.</p>	<p>Headboard Post Left</p>  <p>(H-B) 1 pc.</p>	<p>Headboard Post Right</p>  <p>(H-C) 1 pc.</p>	<p>Headboard stretcher</p>  <p>(H-D) 1 pc.</p>	
<p>Allen Head Bolt ø5/16"-18 x 1-1/2"</p>  <p>(H-E) 2 pcs.</p>	<p>Allen Head Bolt ø5/16"-18 x 1-3/4"</p>  <p>(H-F) 6 pcs.</p>	<p>Spring Washer ø5/16"</p>  <p>(H-G) 8 pcs.</p>	<p>Flat Washer ø5/16" x 19*2mm</p>  <p>(H-H) 8 pcs.</p>	<p>Allen Key 5mm</p>  <p>(H-I) 1 pc.</p>

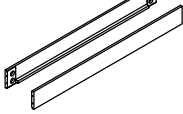
Hardware and Parts packed with the Footboard

<p>Louver Footboard 37277</p>  <p>(F-A) 1 pc.</p>	<p>Wood Slats 61-1/4" long</p>  <p>(F-B) 1 Set.</p>	<p>Support Leg (D) 7-1/2" x (W)1- 1/4"(H) 1- 1/4"</p>  <p>(F-C) 5 pcs.</p>	<p>Wood Screw #8 x 1"</p>  <p>(F-D) 10 pcs.</p>
---	---	--	---

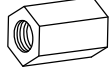
Hardware and Parts packed with the Bed Rail

<p>Bed Rails 37272</p>  <p>(R-A) 2 pcs.</p>	<p>All-Thread Bolt ø5/16-18 x 3-1/2"</p>  <p>(R-B) 8 pcs.</p>	<p>Curved Washer ø5/16"</p>  <p>(R-C) 8 pcs.</p>	<p>Flat Washer ø5/16" x 16*2mm</p>  <p>(R-D) 8 pcs.</p>	<p>Spring Washer ø5/16"</p>  <p>(R-E) 8 pcs.</p>	<p>Hex Nut ø5/16 x L17</p>  <p>(R-F) 8 pcs.</p>	<p>Open Wrench 12mm</p>  <p>(R-G) 1 pc.</p>
---	--	---	--	--	--	--

5/0 Queen Bed

37276 -- 4/6-5/0 Louver Headboard

37277 -- 5/0 Louver Footboard

37272 -- 5/0-6/6 Panel Bed Rails

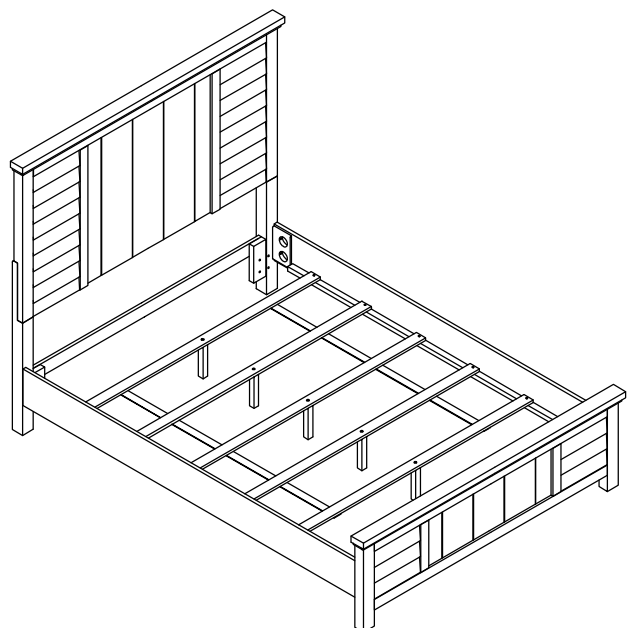

5/0 Queen Bed
37276 -- 4/6-5/0 Louver Headboard

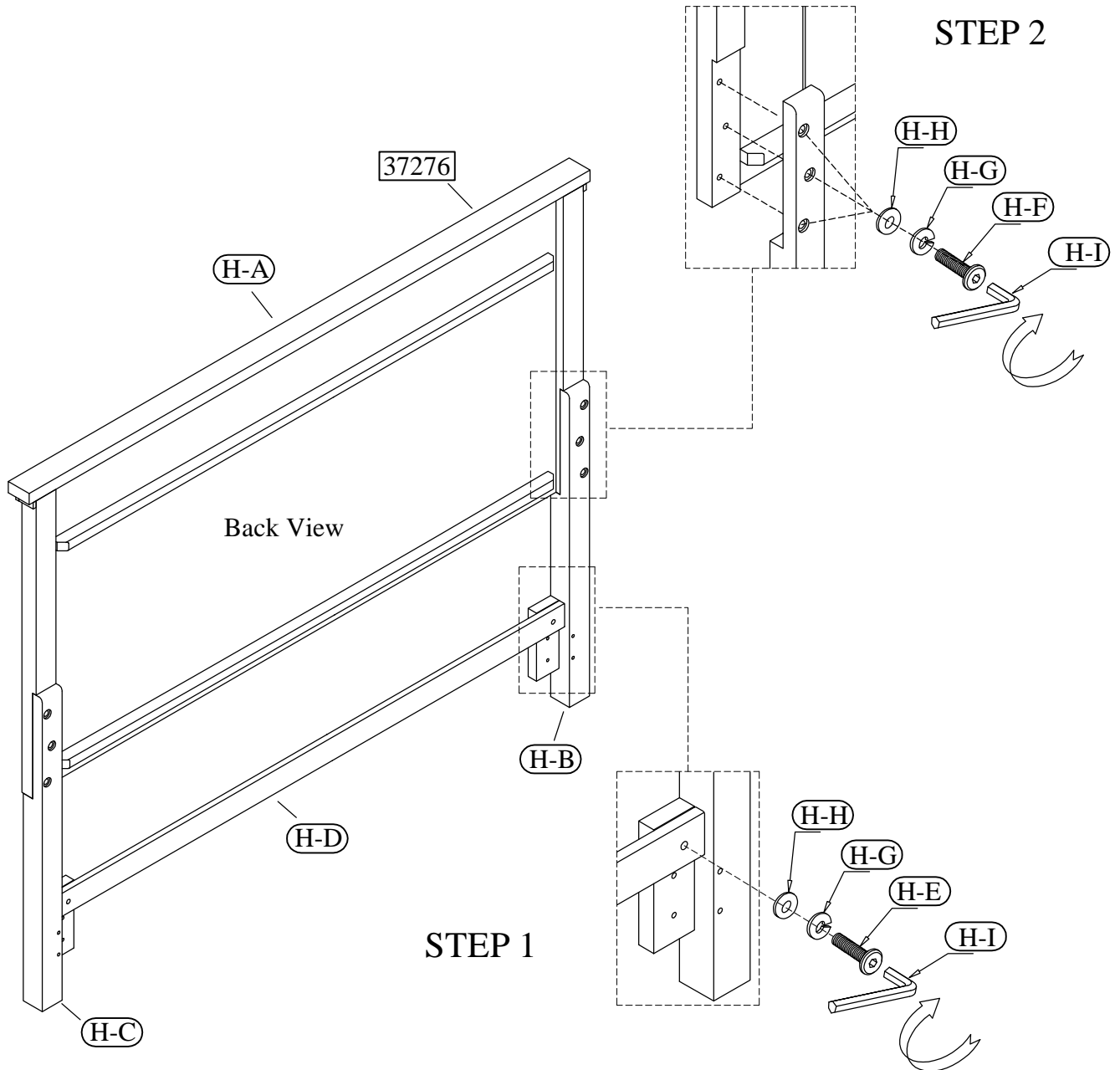

5/0 Queen Bed

37276 -- 4/6-5/0 Louver Headboard

37277 -- 5/0 Louver Footboard

STEP 3

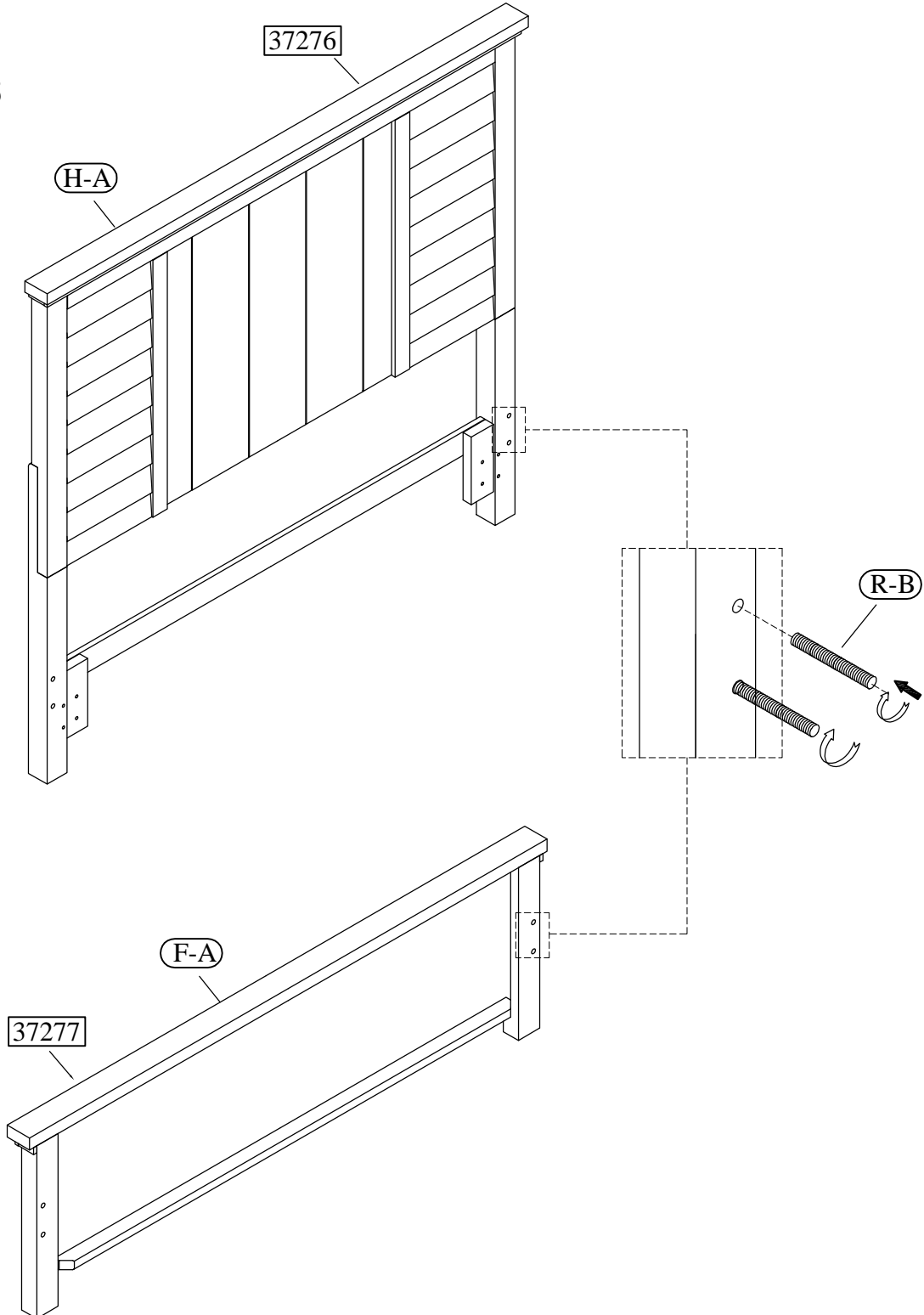

STEP 4

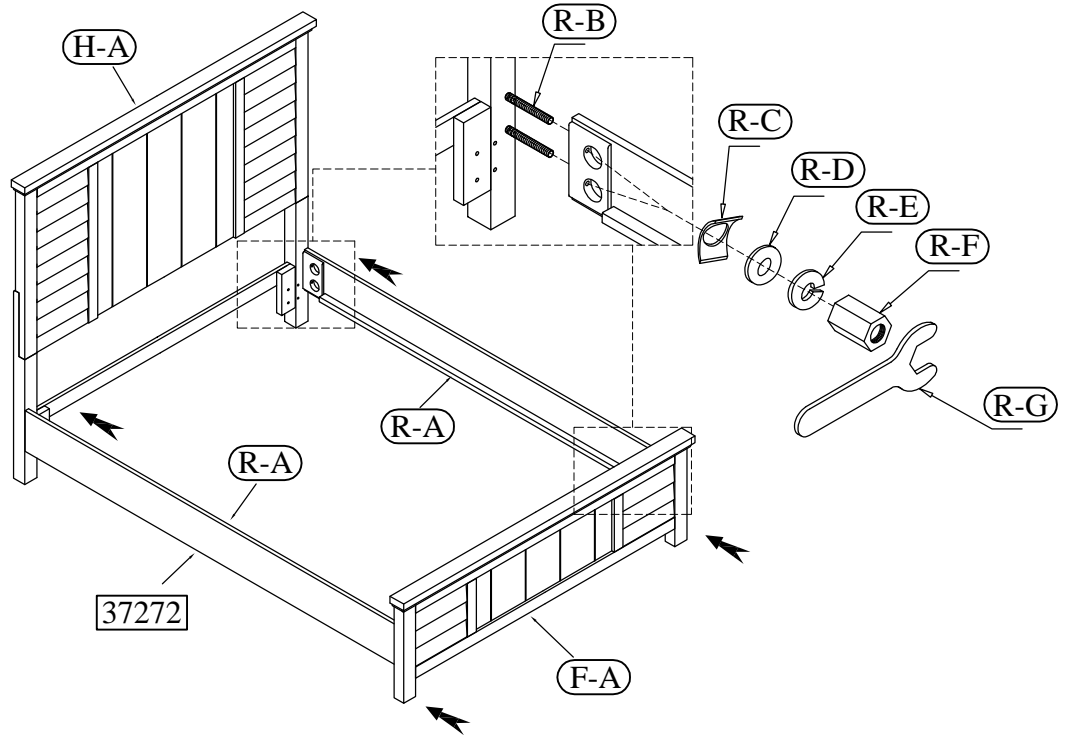

STEP 5

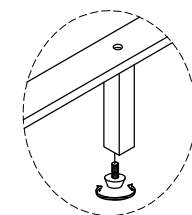
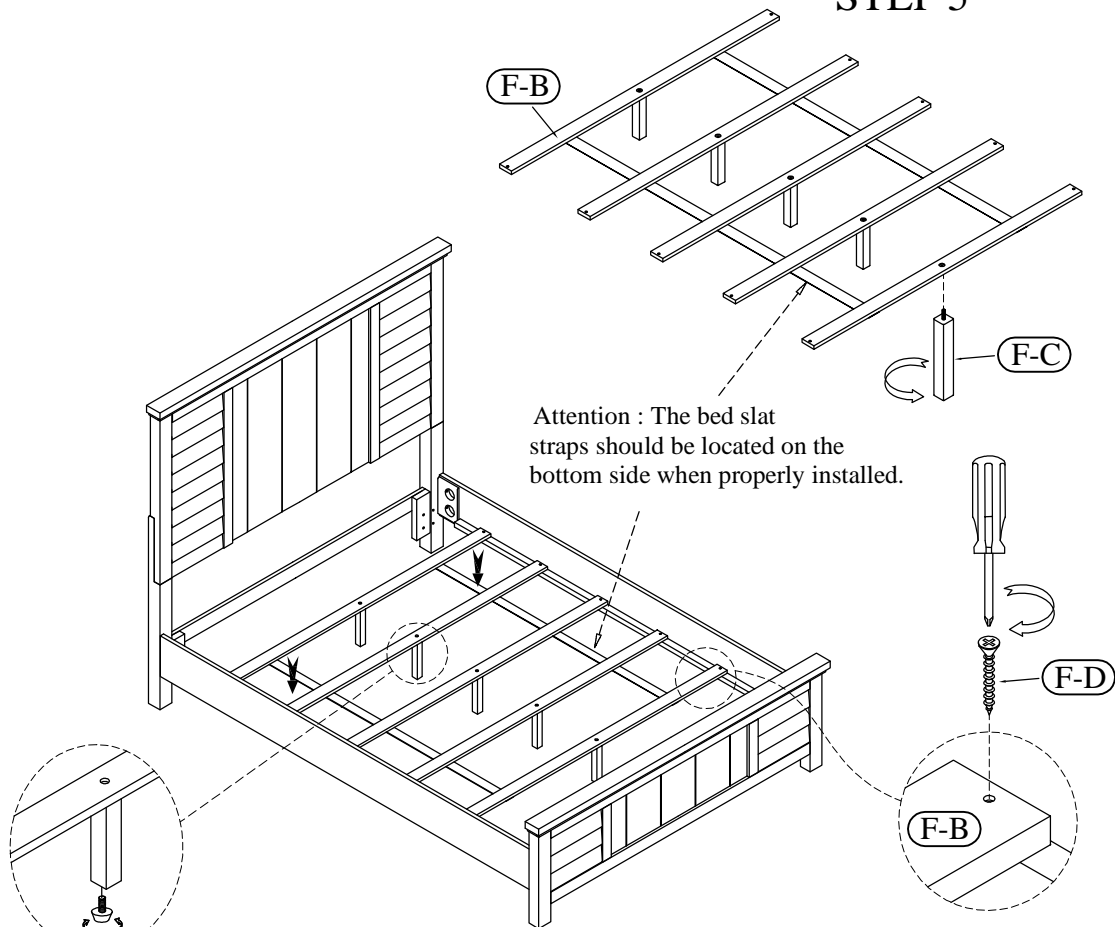

STEP 6

5/0 Queen Bed
37276 -- 4/6-5/0 Louver Headboard

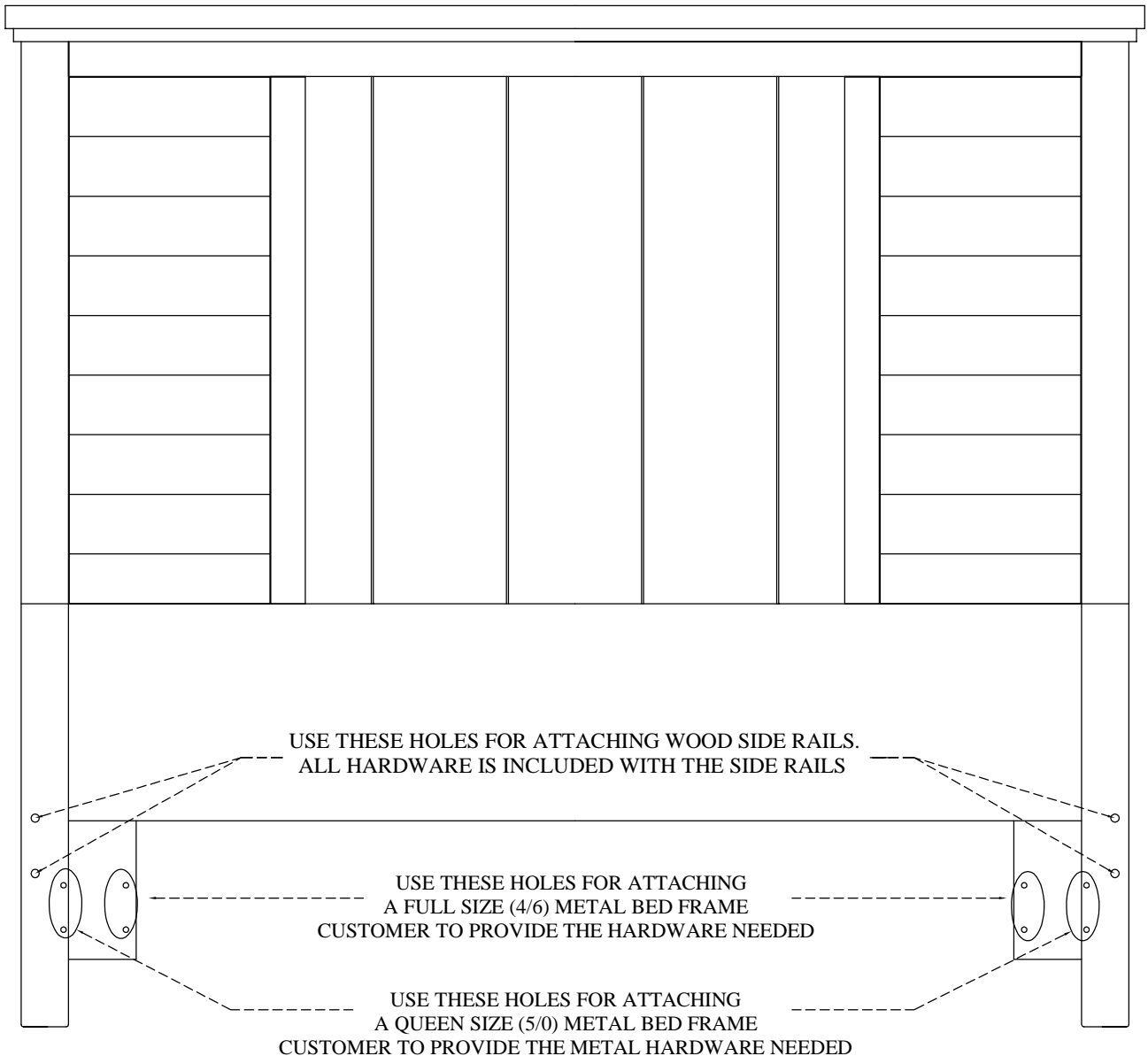

4/6 & 5/0 Bed
THE HEADBOARD MAY BE USED ALONE WITH
A QUEEN OR FULL SIZE METAL BED FRAME.